

RECTANGLE

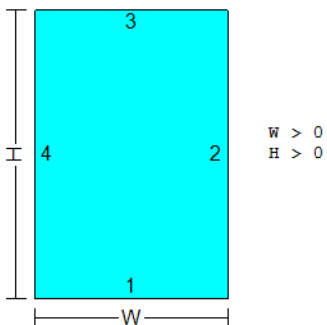

SHAPE 1

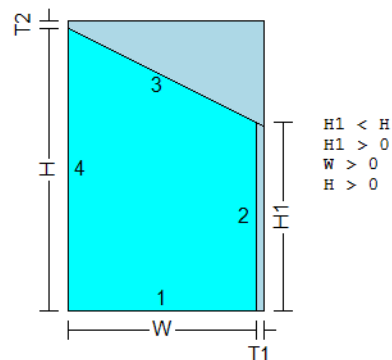

SHAPE 2

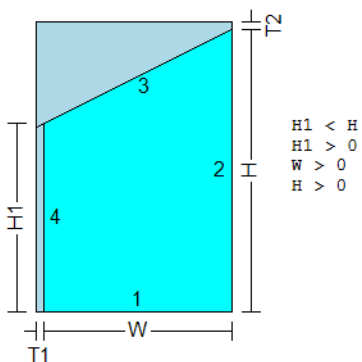

SHAPE 3

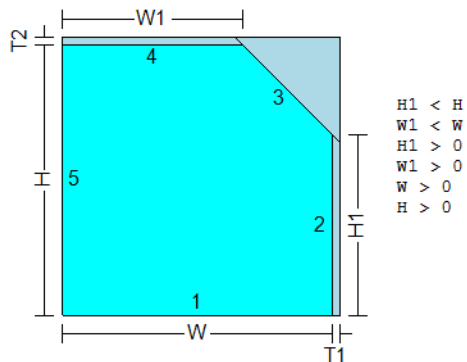

SHAPE 4

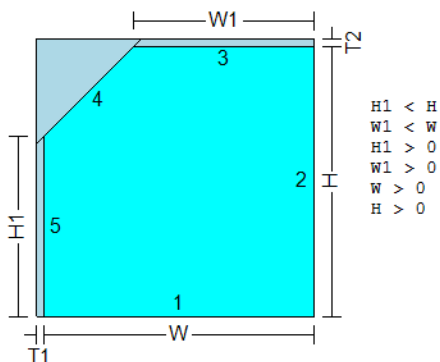

SHAPE 5

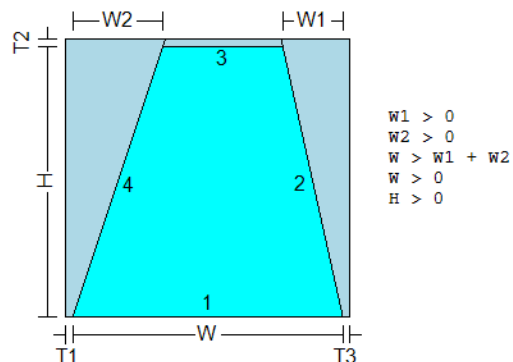

SHAPE 6

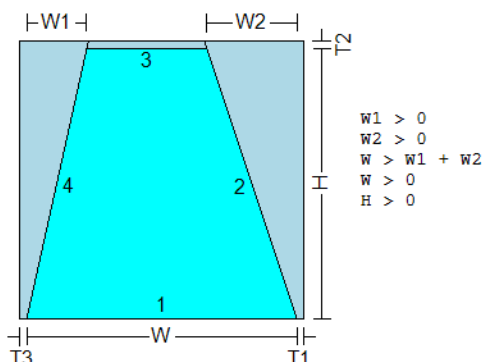

SHAPE 7

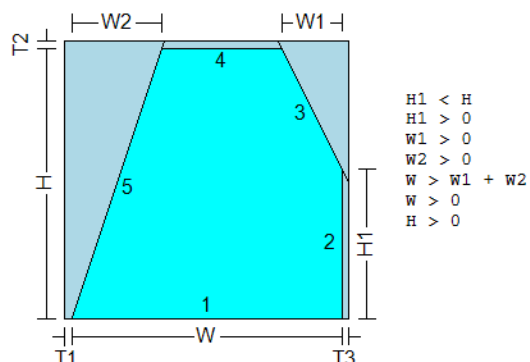

SHAPE 8

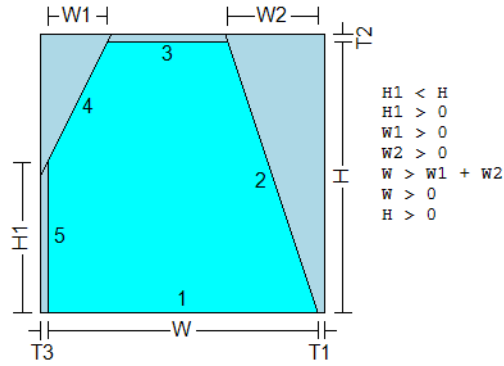

SHAPE 9

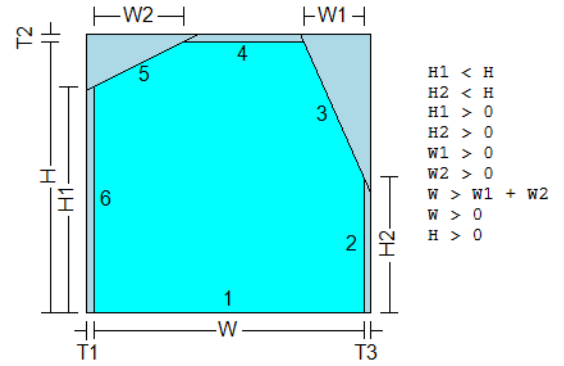

SHAPE 10

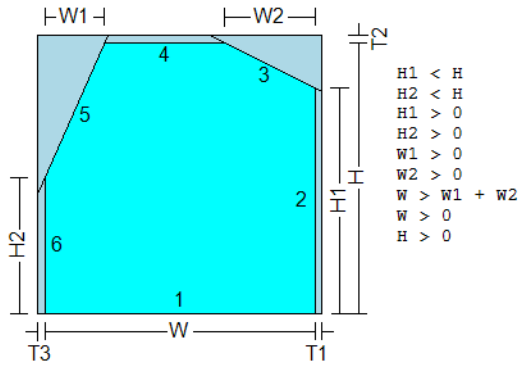

SHAPE 11

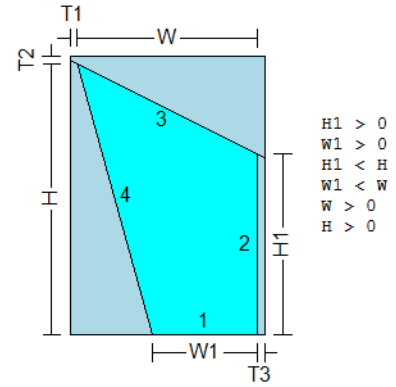

SHAPE 12

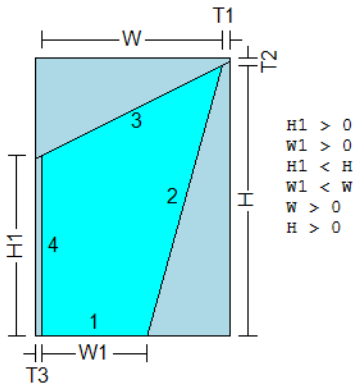

SHAPE 13

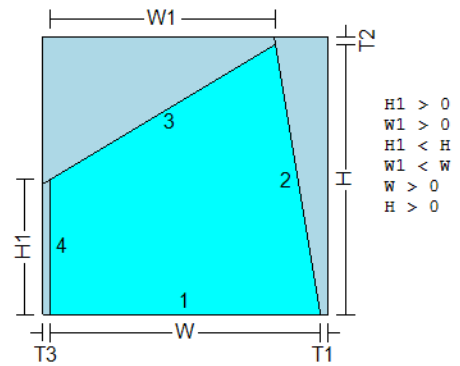

SHAPE 14

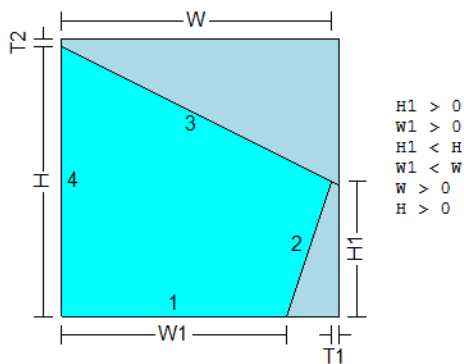

SHAPE 15

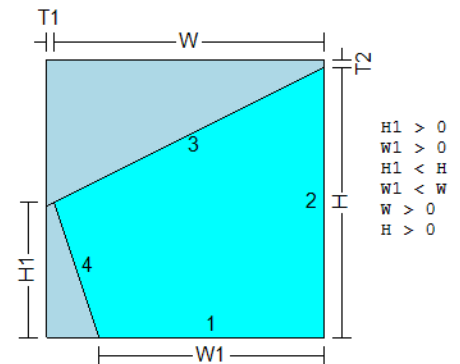

SHAPE 16

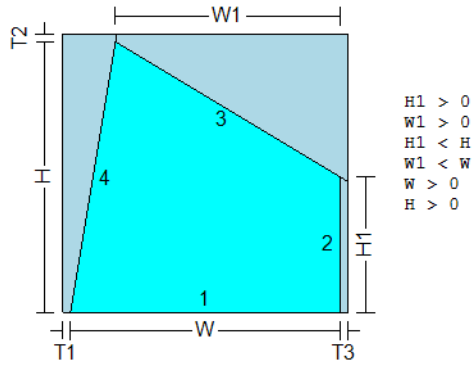

SHAPE 17

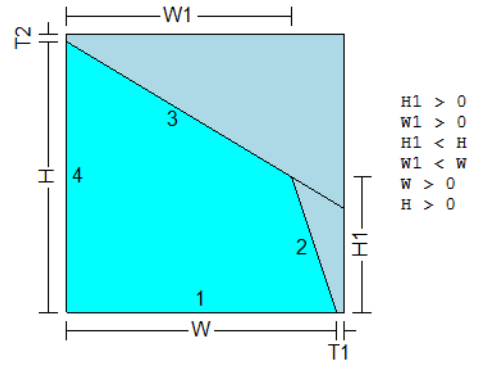

SHAPE 18

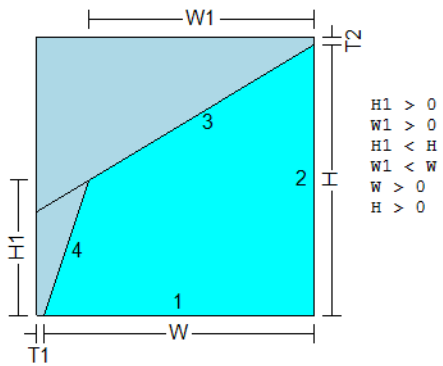

SHAPE 19

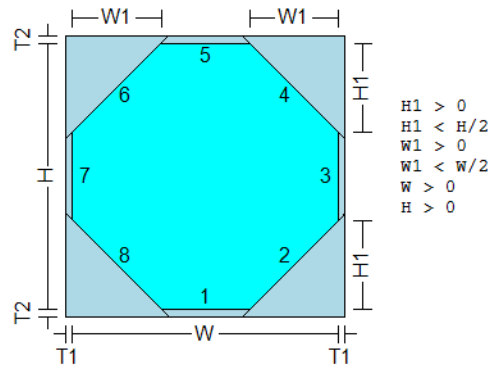

SHAPE 20

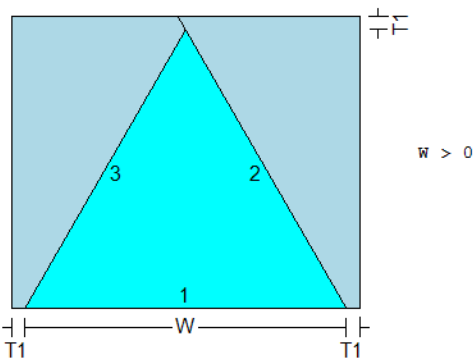

SHAPE 21

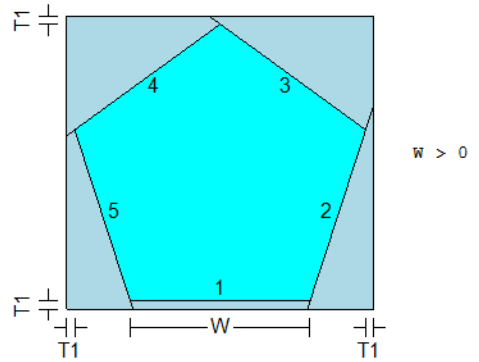

SHAPE 22

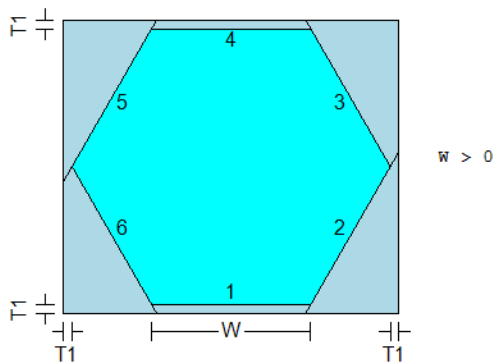

SHAPE 24

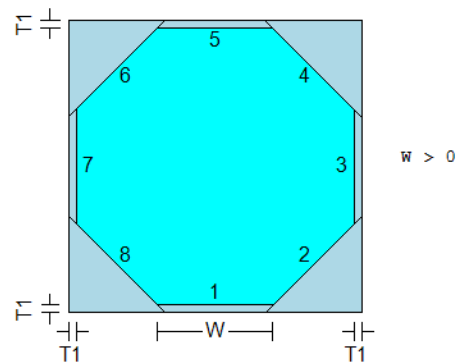

SHAPE 25

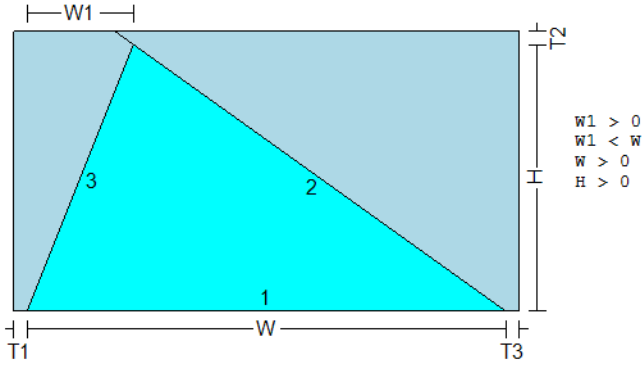

SHAPE 26

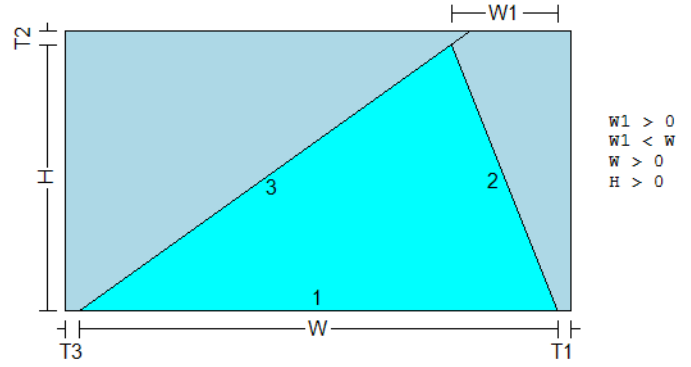

SHAPE 29

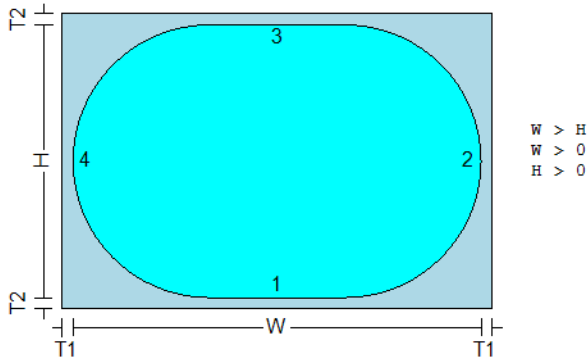

SHAPE 37

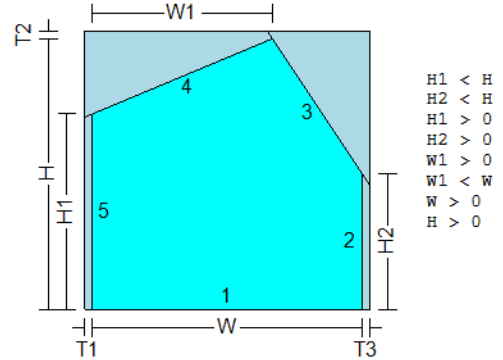

SHAPE 38

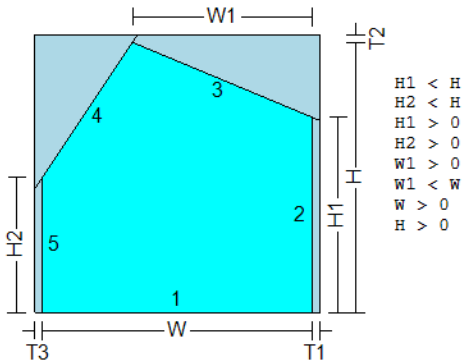

SHAPE 39

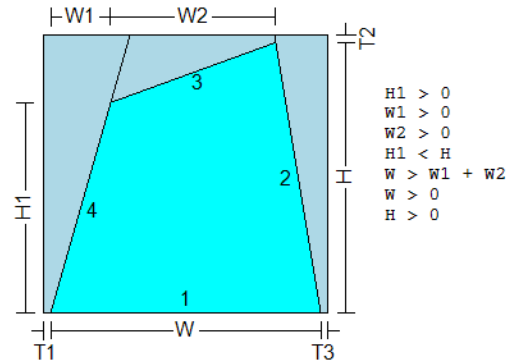

SHAPE 40

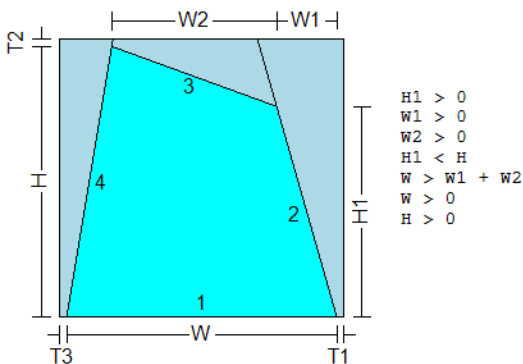

SHAPE 41

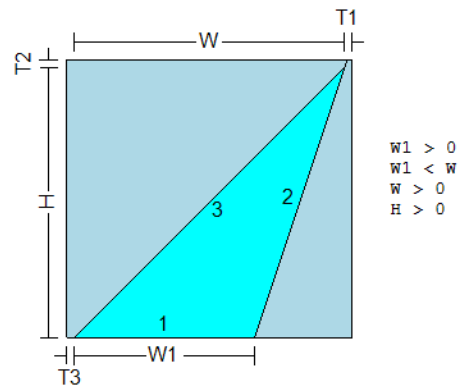

SHAPE 42

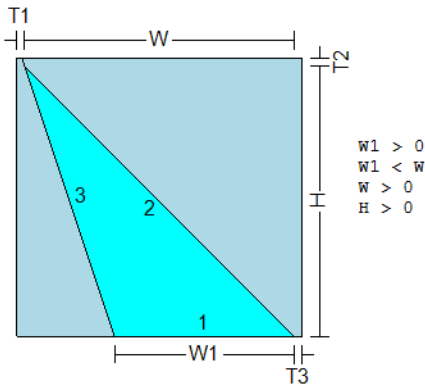

SHAPE 43

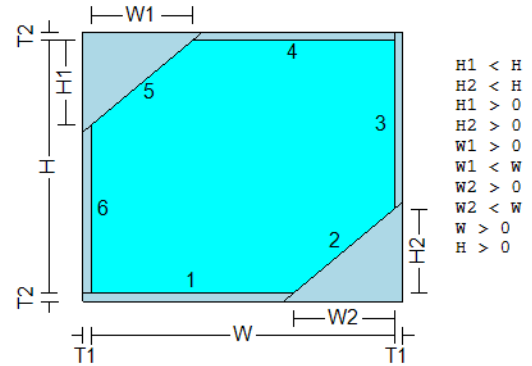

SHAPE 44

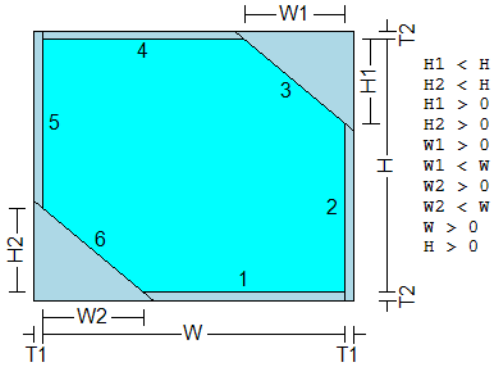

SHAPE 45

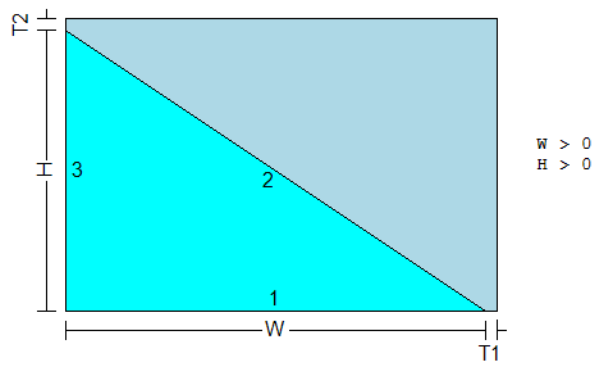

SHAPE 46

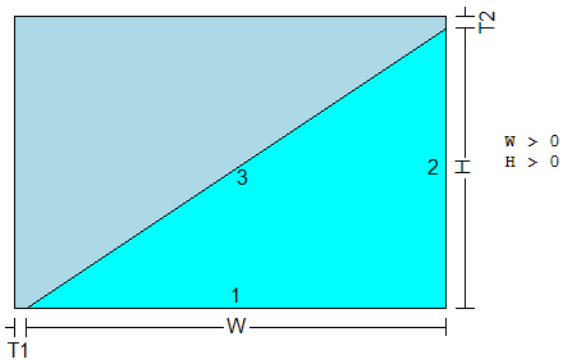

SHAPE 47

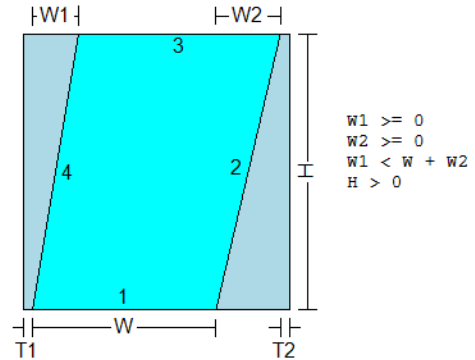

SHAPE 48

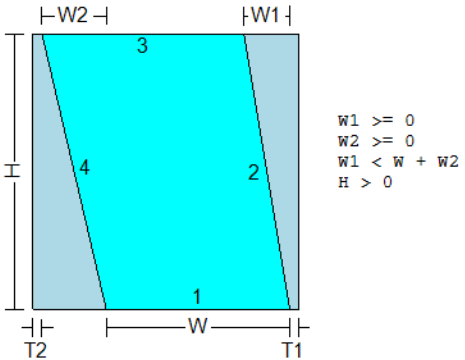

SHAPE 51

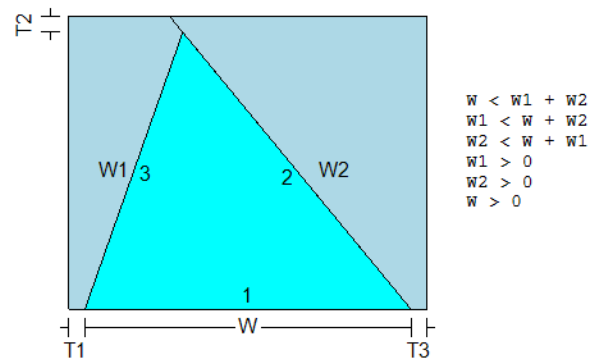

SHAPE 53

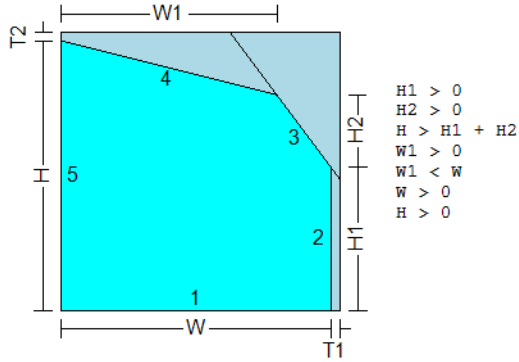

SHAPE 54

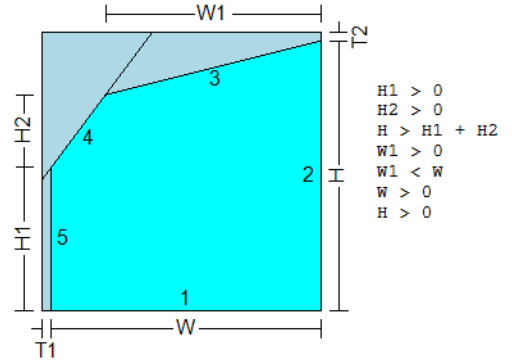

SHAPE 55

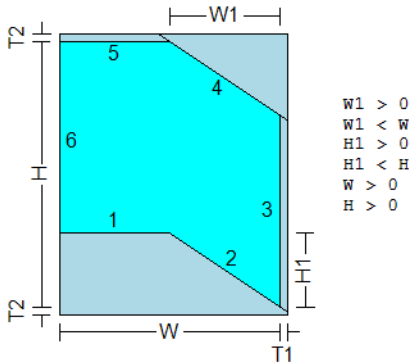

SHAPE 56

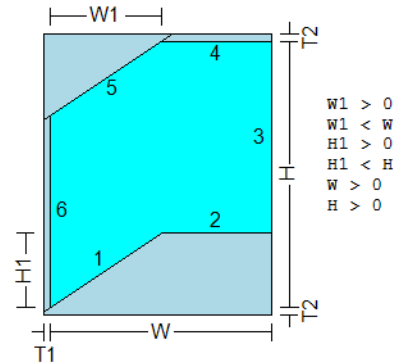

SHAPE 57

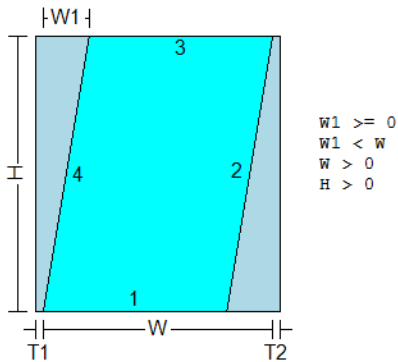

SHAPE 58

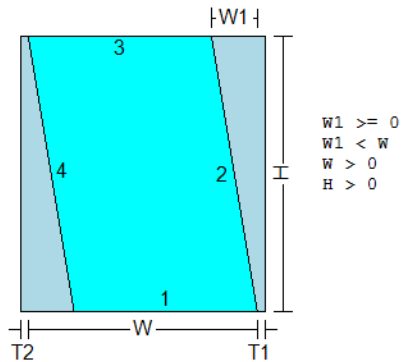

SHAPE 60

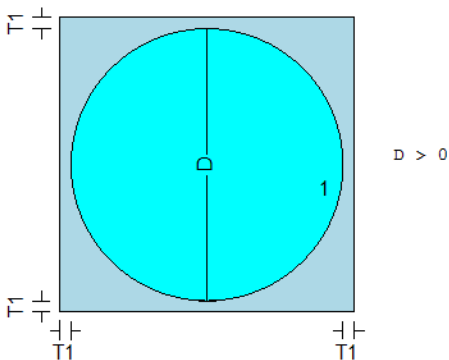

SHAPE 61

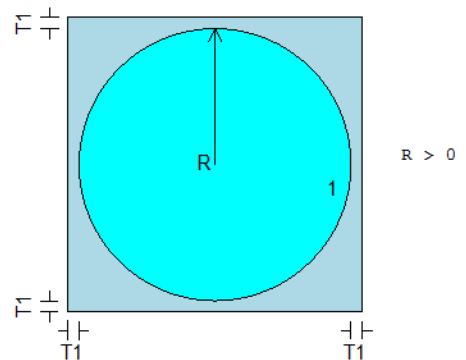

SHAPE 62

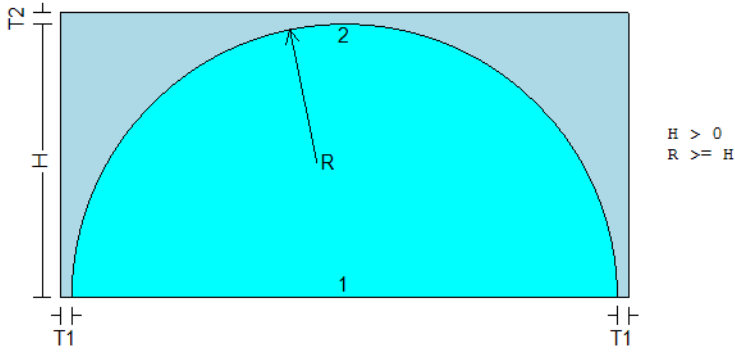

SHAPE 63

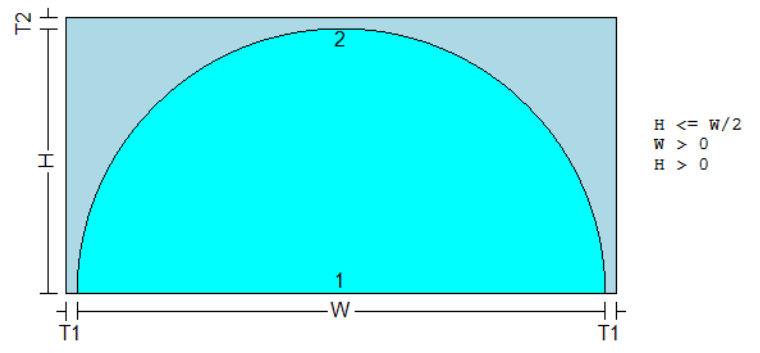

SHAPE 64

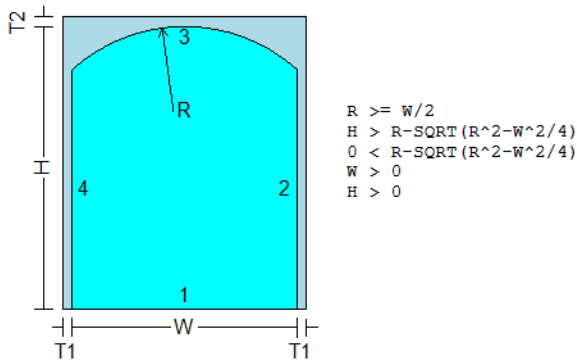

SHAPE 65

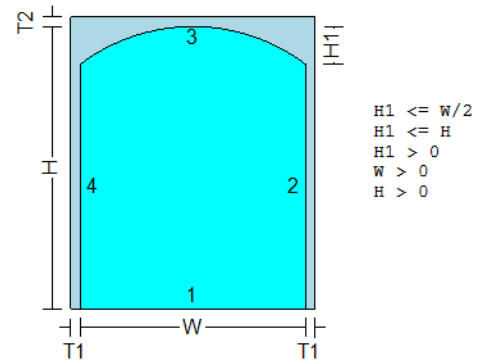

SHAPE 66

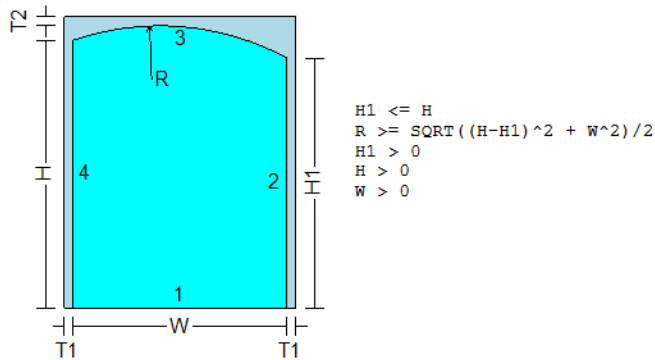

SHAPE 67

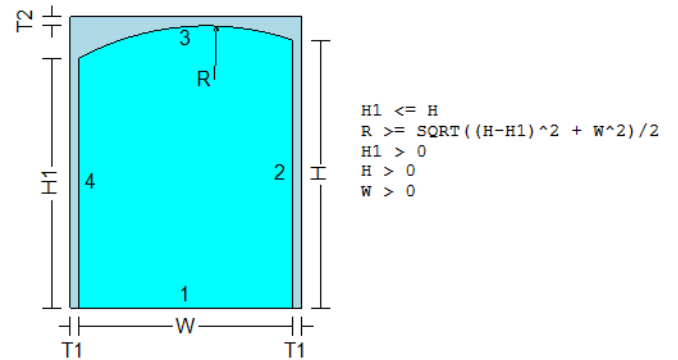

SHAPE 68

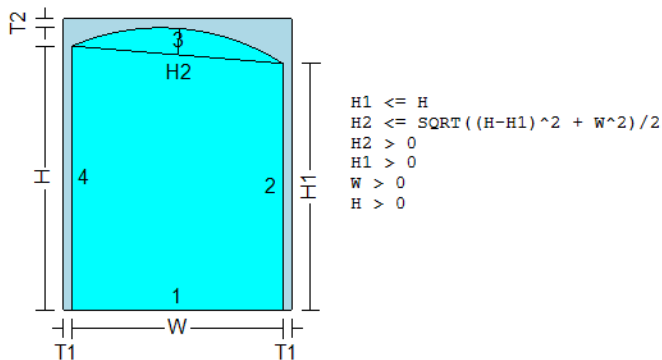

SHAPE 69

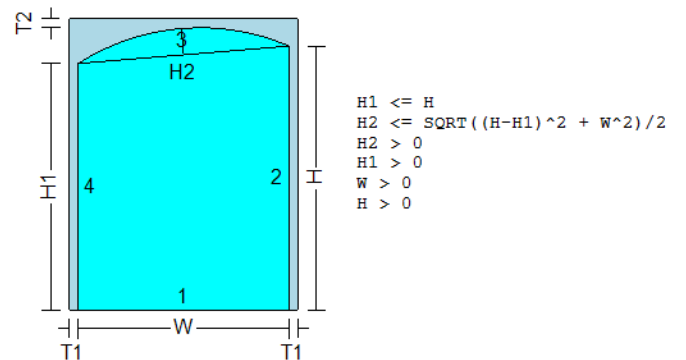

SHAPE 70

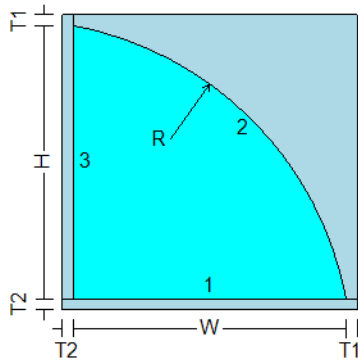

$$R \geq \sqrt{W^2 + H^2} / 2$$

$$W > 0$$

$$H > 0$$

SHAPE 71

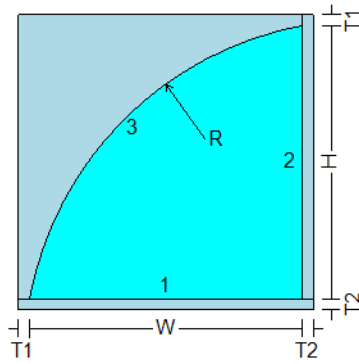

$$R \geq \sqrt{W^2 + H^2} / 2$$

$$W > 0$$

$$H > 0$$

SHAPE 72

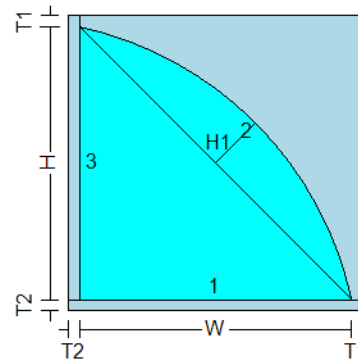

$$H1 \leq \sqrt{W^2 + H^2}$$

$$H1 > 0$$

$$W > 0$$

$$H > 0$$

SHAPE 73

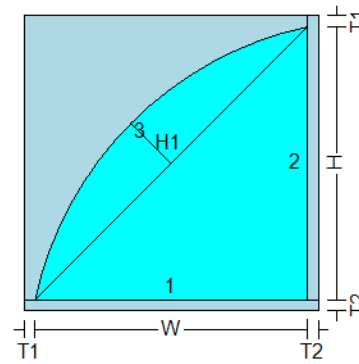

$$H1 \leq \sqrt{W^2 + H^2}$$

$$H1 > 0$$

$$W > 0$$

$$H > 0$$

SHAPE 74

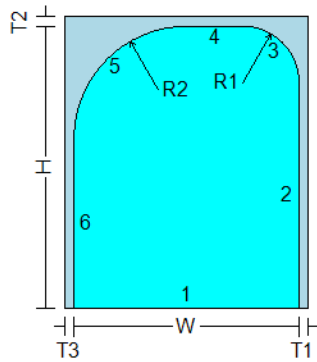

$$W \geq R1 + R2$$

$$R1 > 0$$

$$R1 \leq H$$

$$R2 > 0$$

$$R2 \leq H$$

$$W > 0$$

$$H > 0$$

SHAPE 75

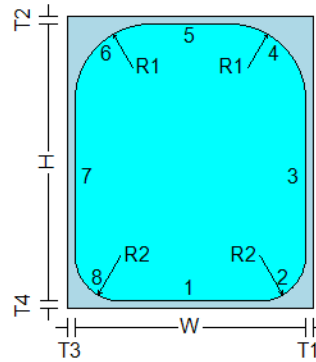

$$H \geq R1 + R2$$

$$R1 > 0$$

$$R1 \leq W/2$$

$$R2 > 0$$

$$R2 \leq W/2$$

$$W > 0$$

$$H > 0$$

SHAPE 76

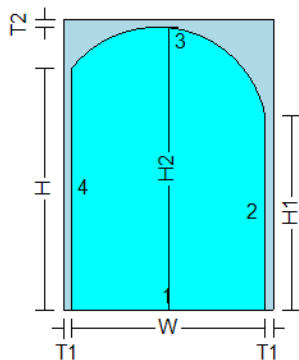

$$W > 0$$

$$H > 0$$

$$H1 > 0$$

$$H2 > 0$$

$$H \geq H1$$

$$H2 > (H + H1) / 2$$

SHAPE 77

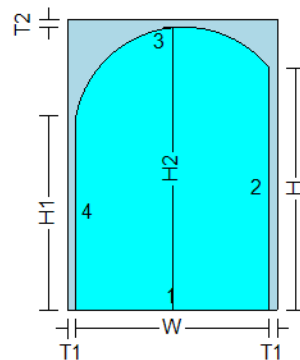

$$W > 0$$

$$H > 0$$

$$H1 > 0$$

$$H2 > 0$$

$$H \geq H1$$

$$H2 > (H + H1) / 2$$



SHAPE 78

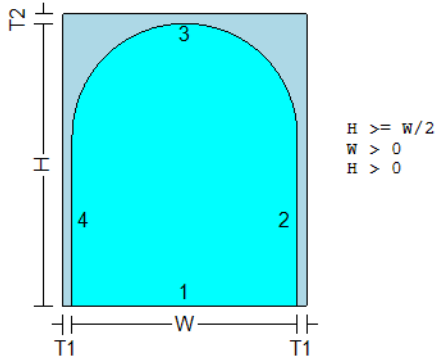

SHAPE 81

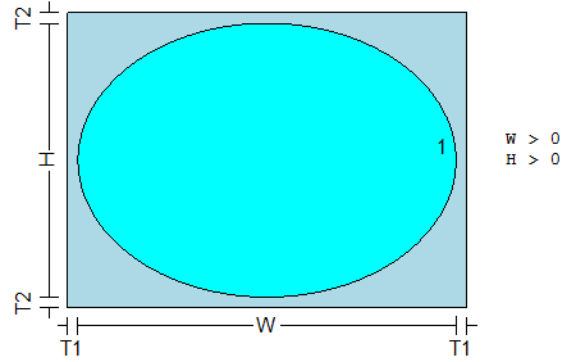

SHAPE 91

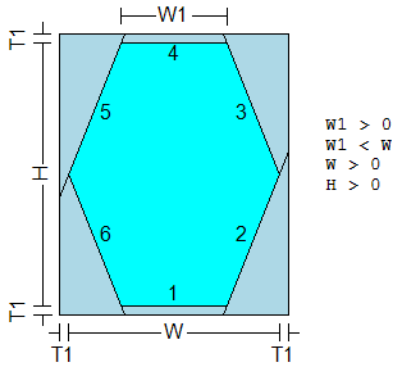

SHAPE 92

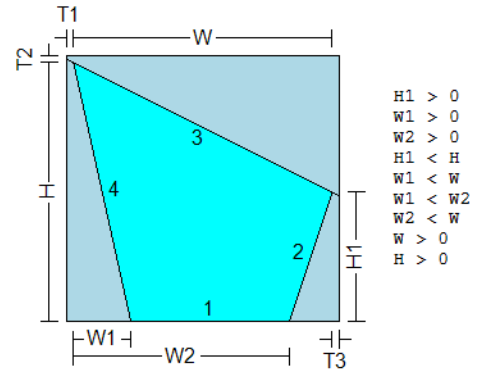

SHAPE 93

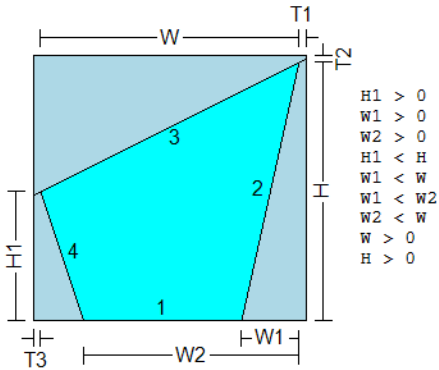

SHAPE 94

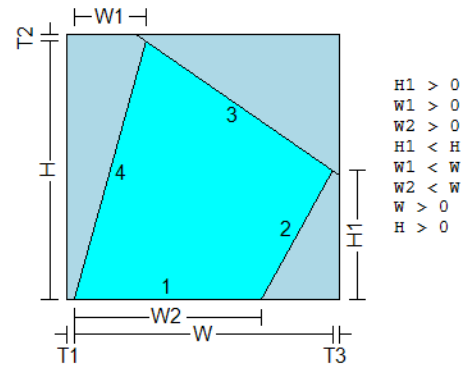

SHAPE 95

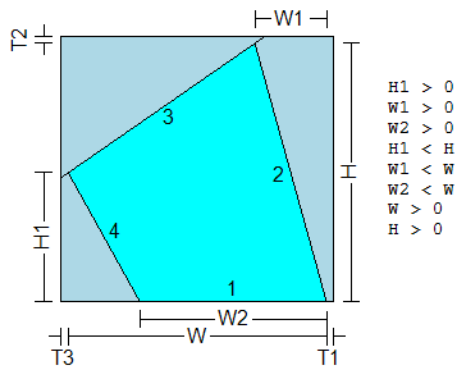

SHAPE 96

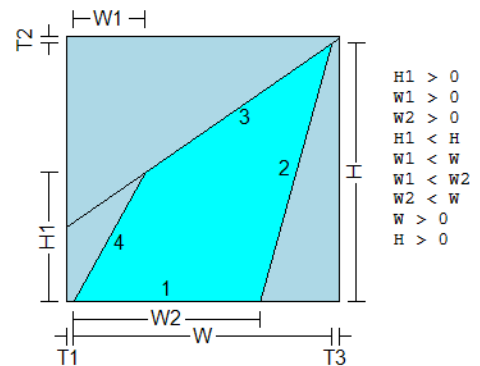

SHAPE 97

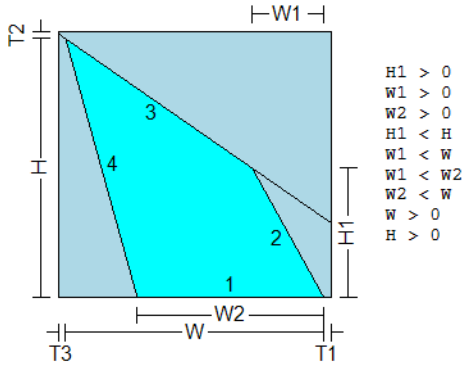

SHAPE 100

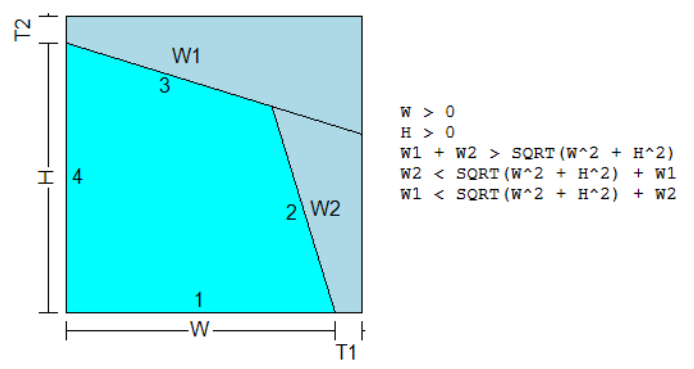

SHAPE 101

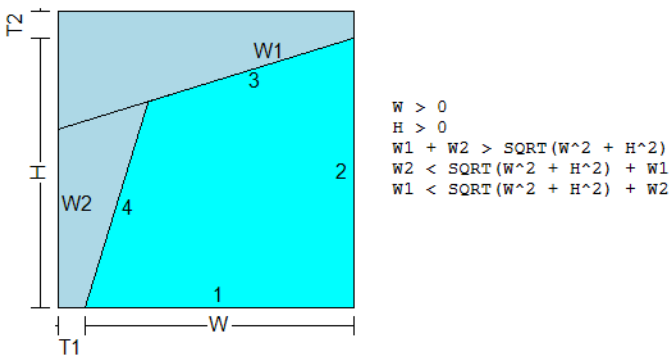

SHAPE 103

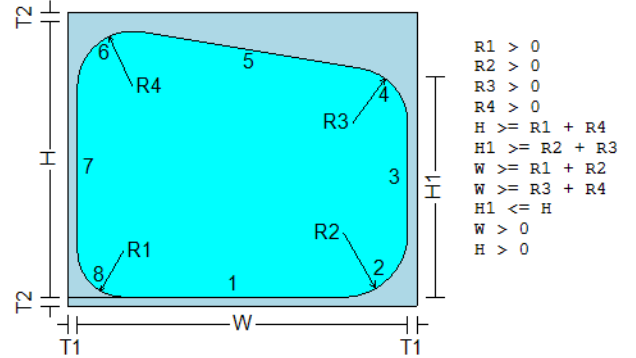

SHAPE 113

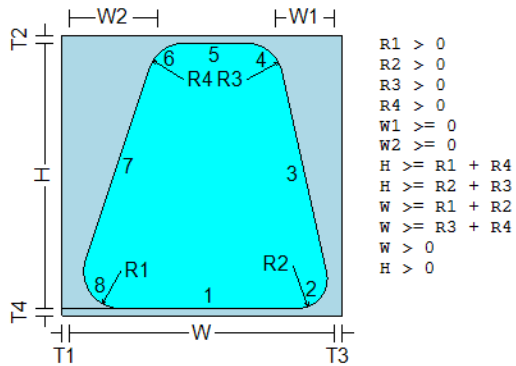

SHAPE 116

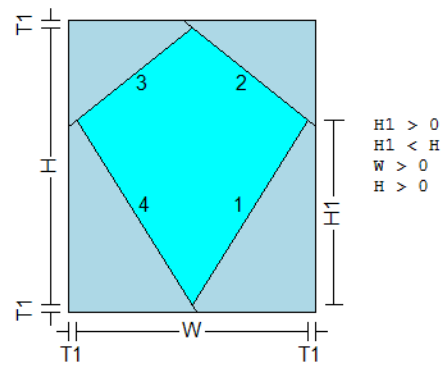

SHAPE 117

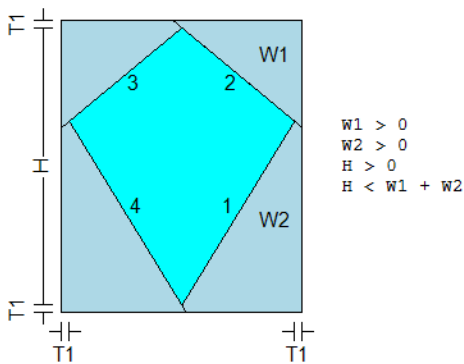

SHAPE 119

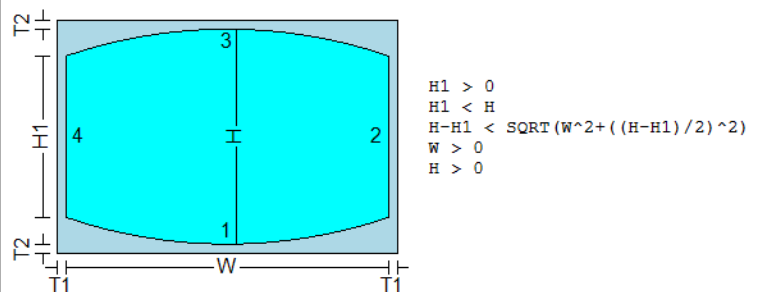

SHAPE 129

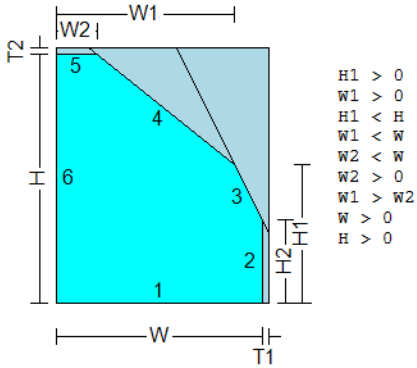

SHAPE 130

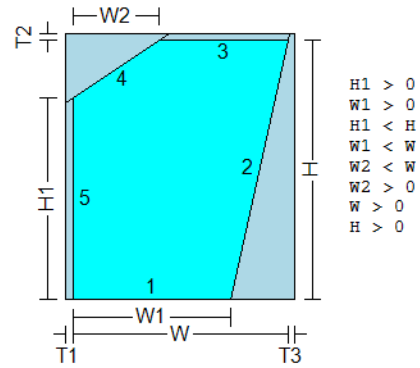

SHAPE 131

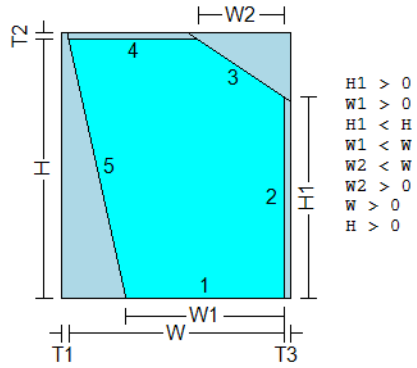

SHAPE 132

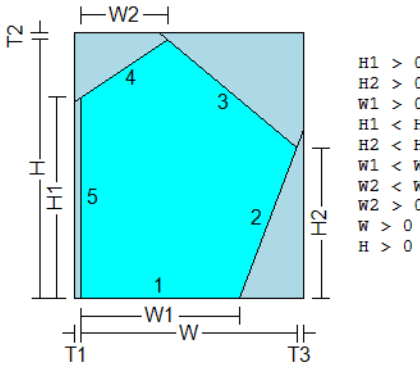

SHAPE 133

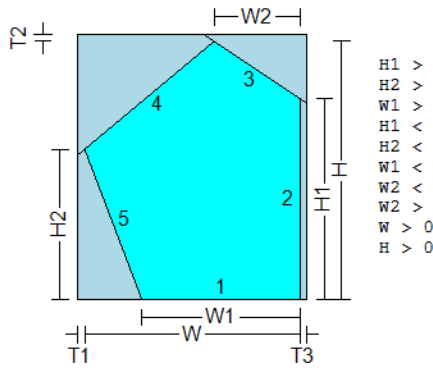

SHAPE 134

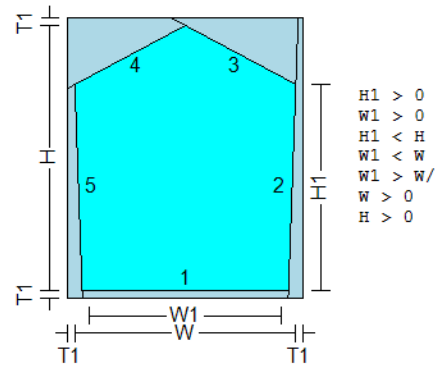

SHAPE 135

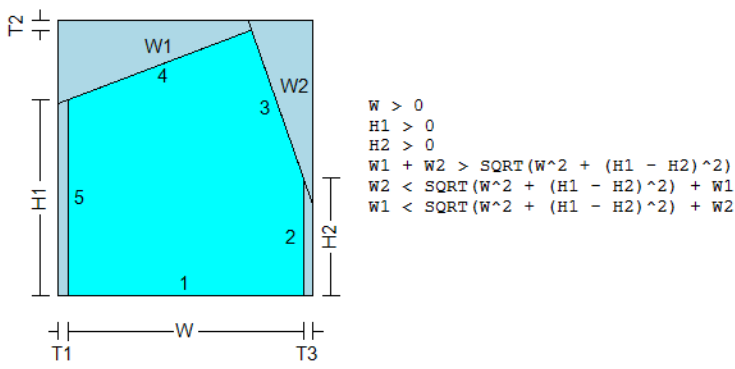

SHAPE 142

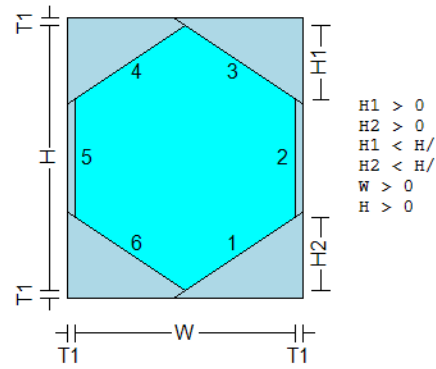

SHAPE 144

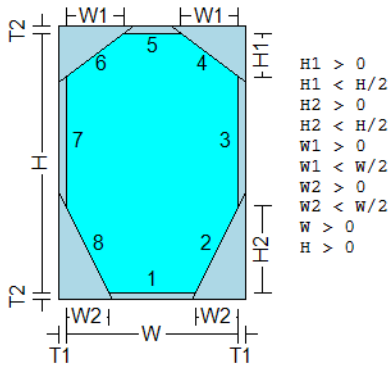

SHAPE 152

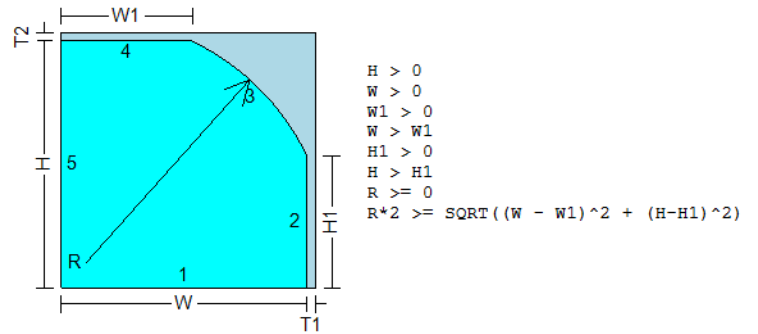

SHAPE 153

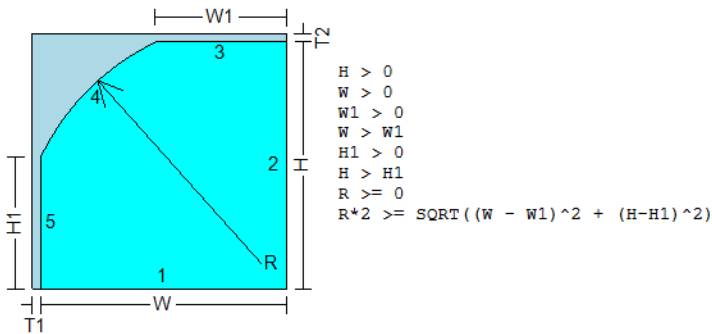

SHAPE 154

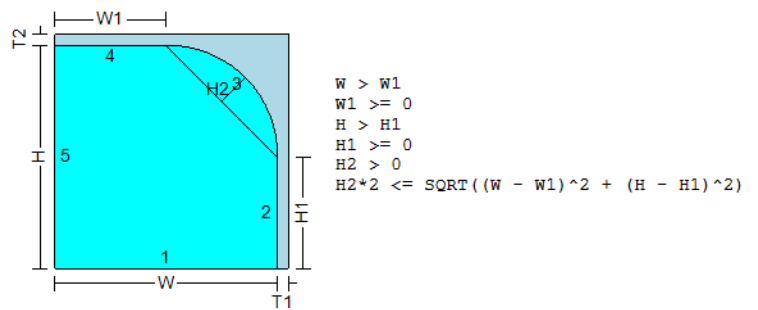

SHAPE 155

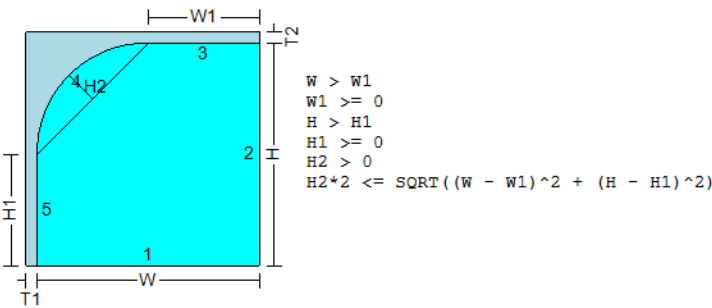

SHAPE 156

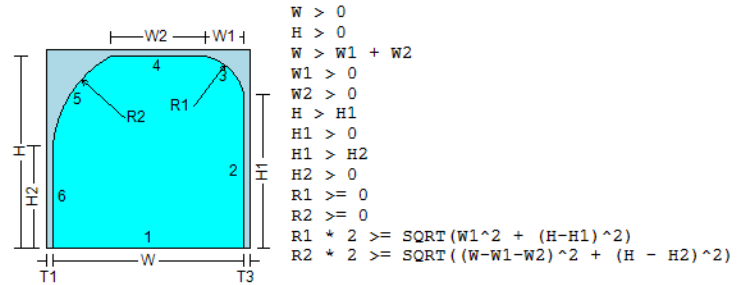

SHAPE 157

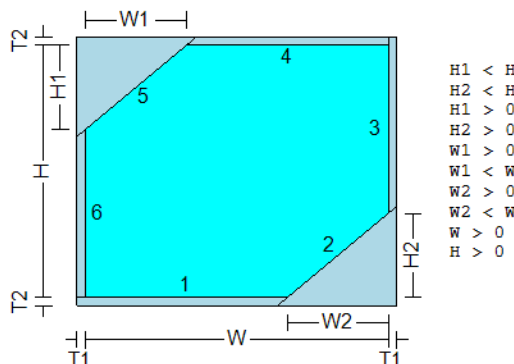

SHAPE 160

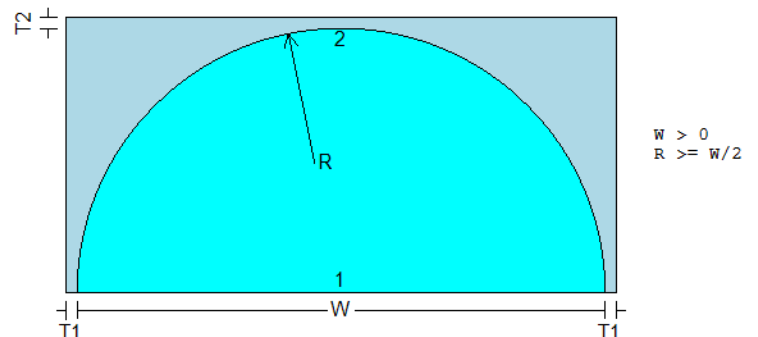

SHAPE 162

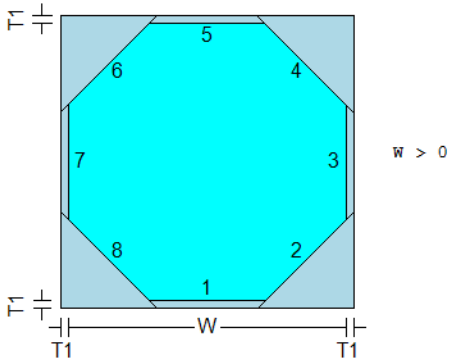

SHAPE 169

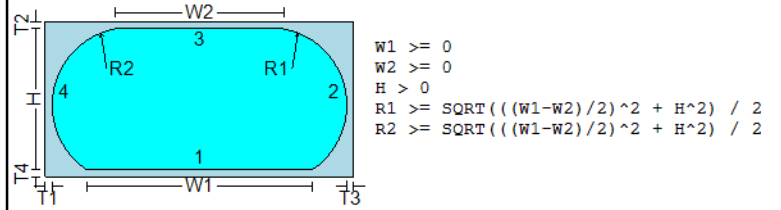

SHAPE 170

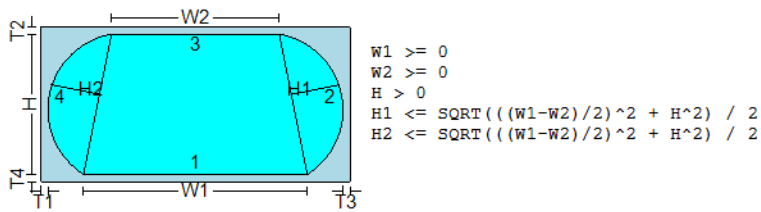

SHAPE 215

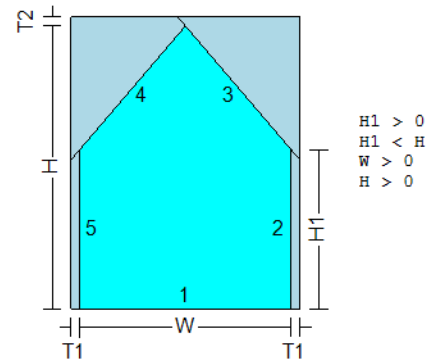

SHAPE 238

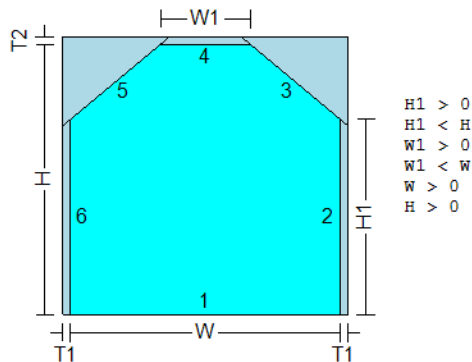

SHAPE 254

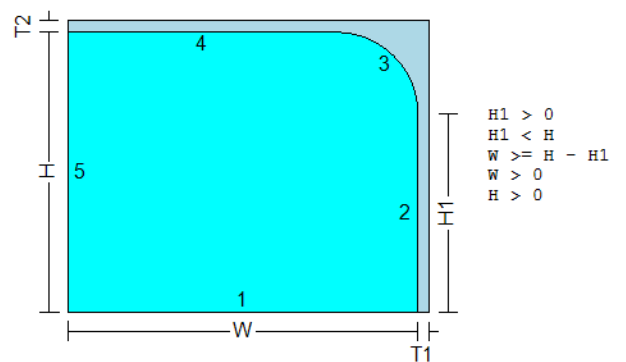

SHAPE 255

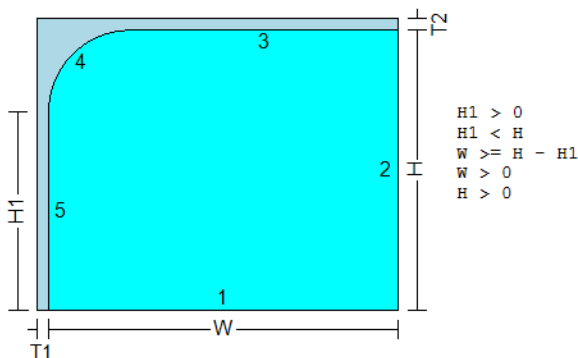

SHAPE 261

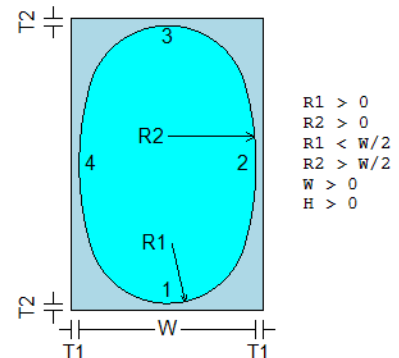

SHAPE 262

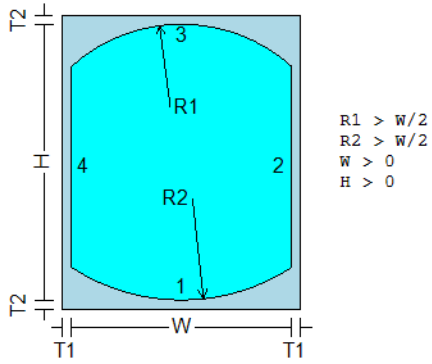

SHAPE 272

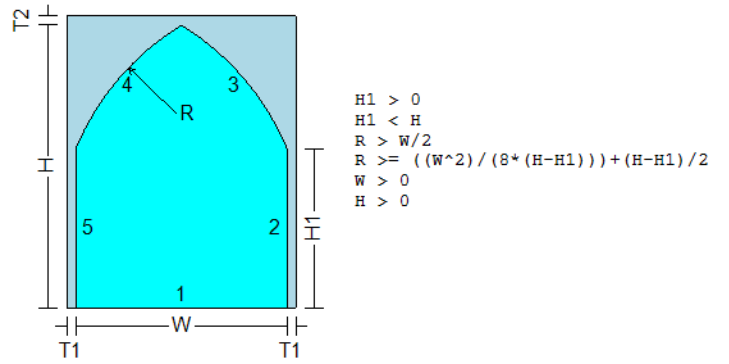

SHAPE 277

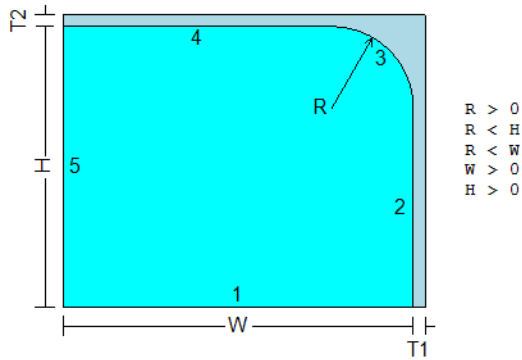

SHAPE 278

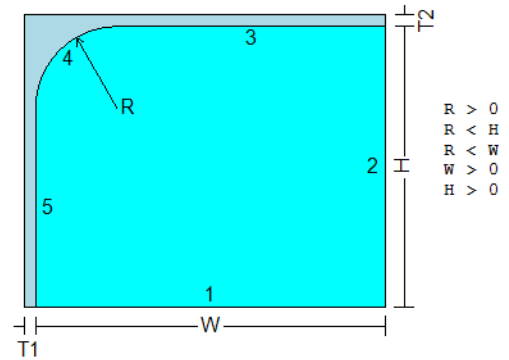

SHAPE 301

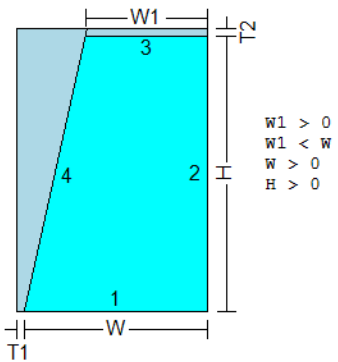

SHAPE 302

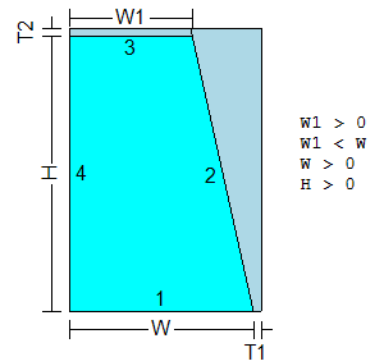

SHAPE 303

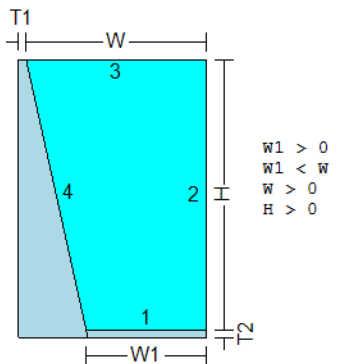

SHAPE 304

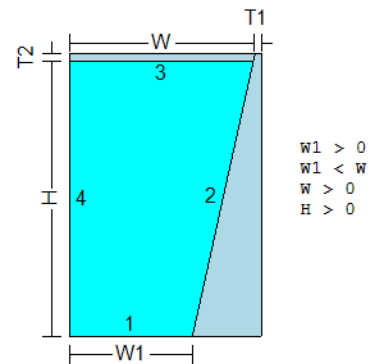

SHAPE 305

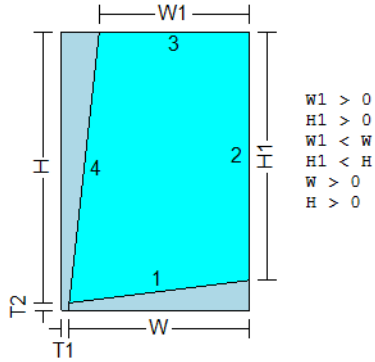

SHAPE 306

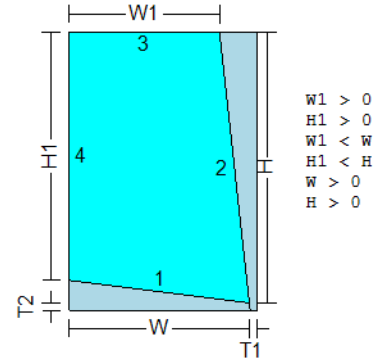

SHAPE 307

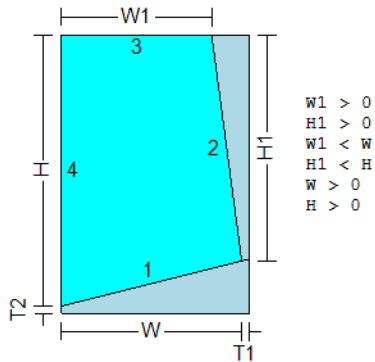

SHAPE 308

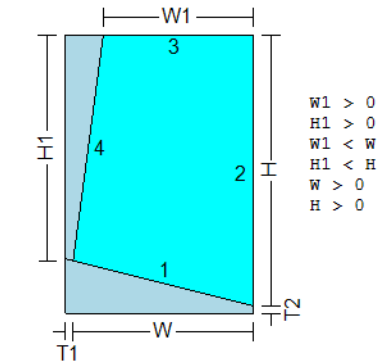

SHAPE 309

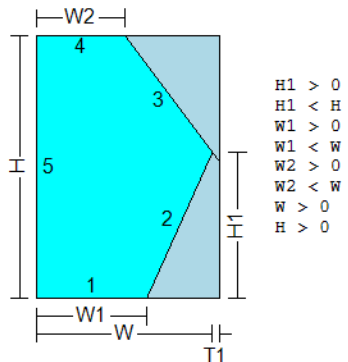

SHAPE 310

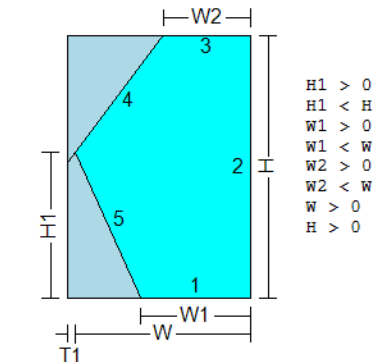

SHAPE 311

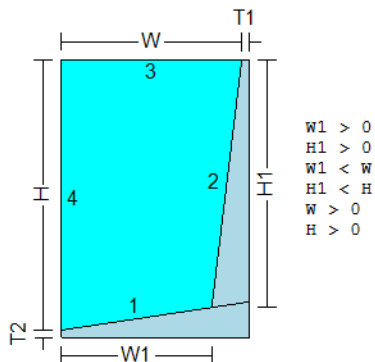

SHAPE 312

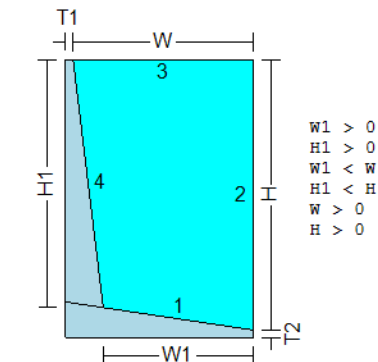

SHAPE 313

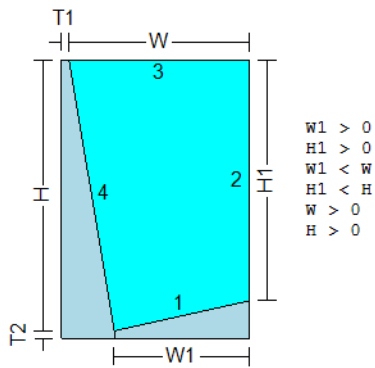

SHAPE 314

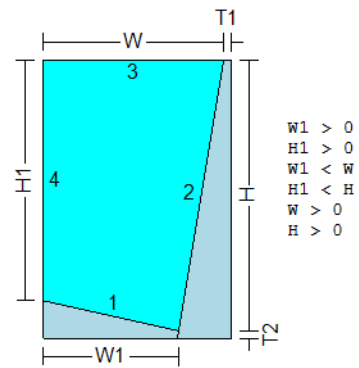

SHAPE 315

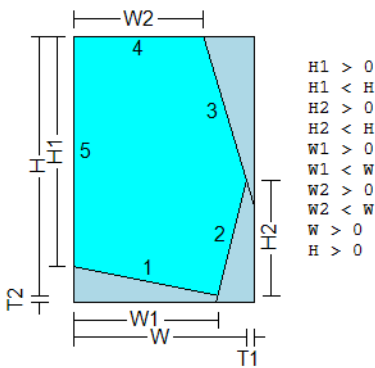

SHAPE 316

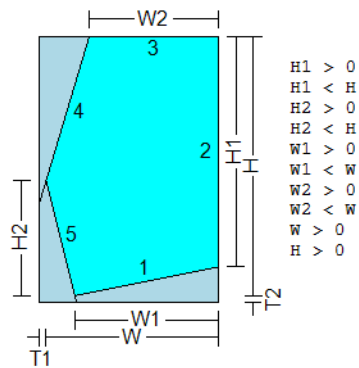

SHAPE 317

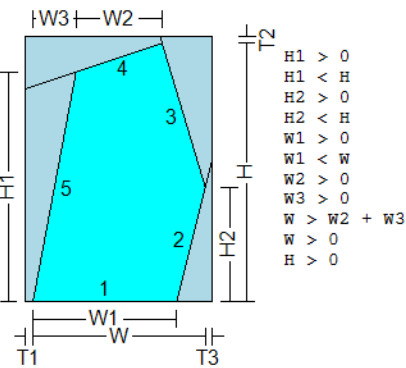

SHAPE 318

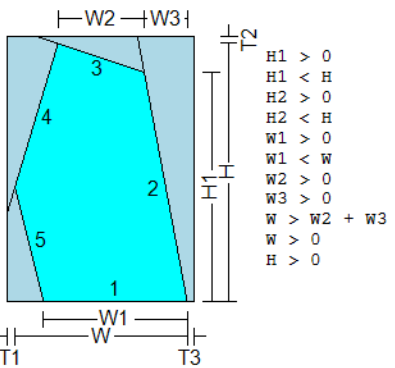

SHAPE 319

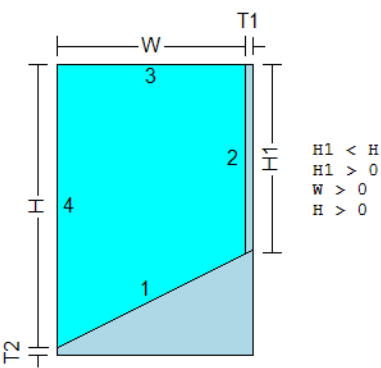

SHAPE 320

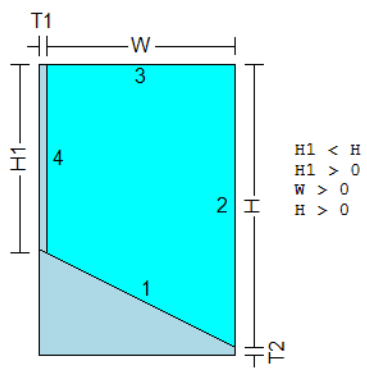



SHAPE 321

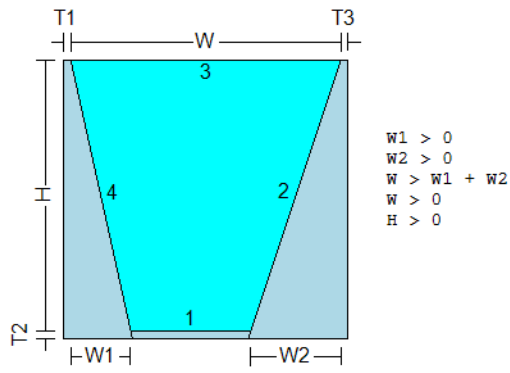

SHAPE 322

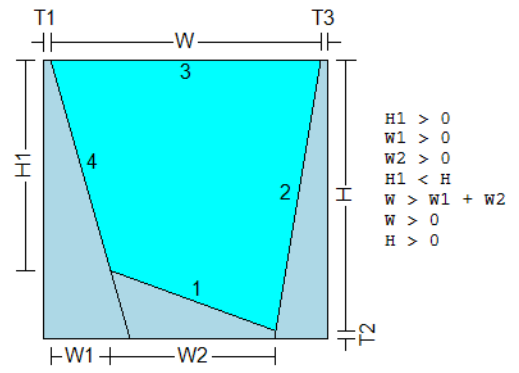

SHAPE 323

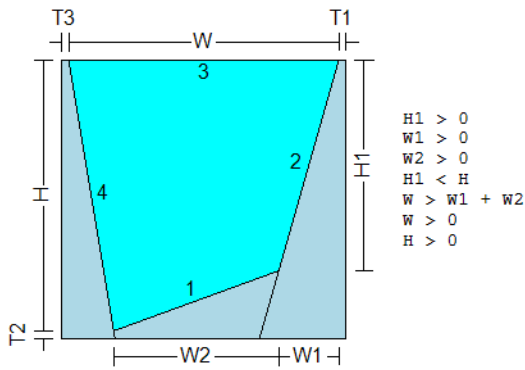

SHAPE 324

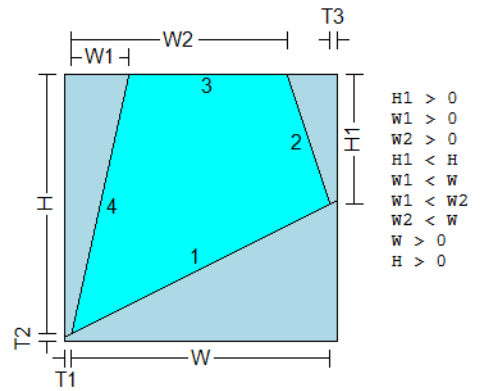

SHAPE 325

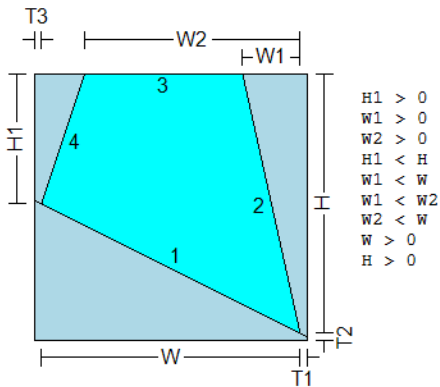

SHAPE 326

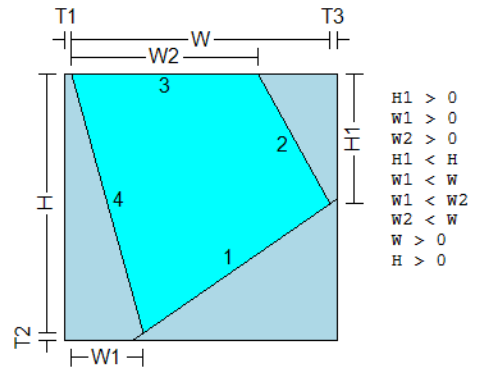

SHAPE 327

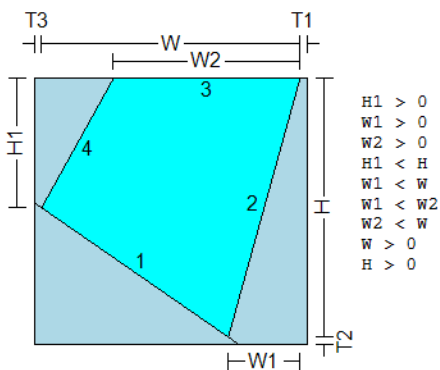

SHAPE 328

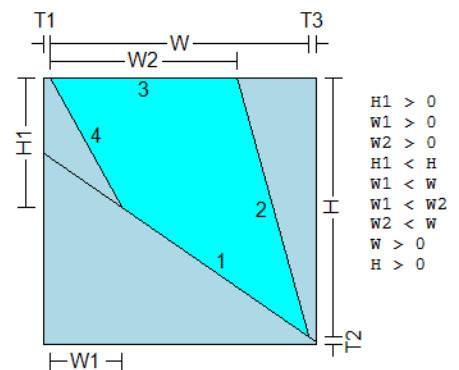

SHAPE 329

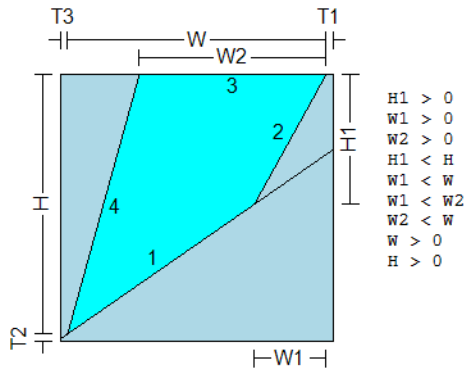

SHAPE 330

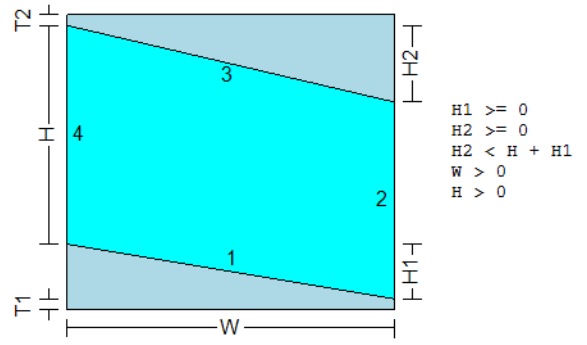

SHAPE 331

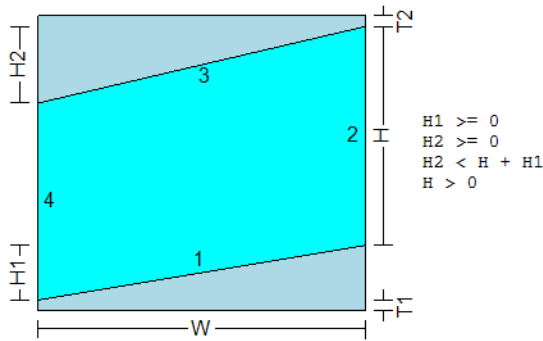

SHAPE 332

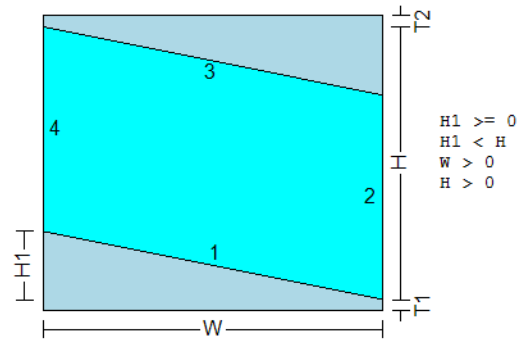

SHAPE 333

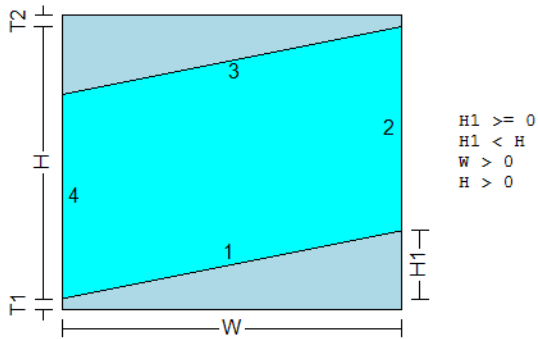

SHAPE 334

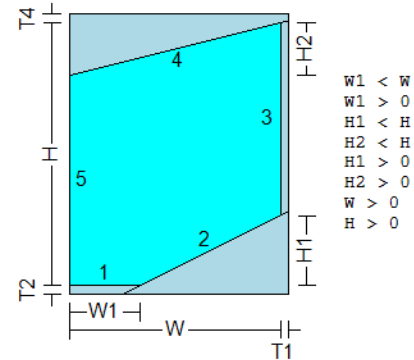

SHAPE 335

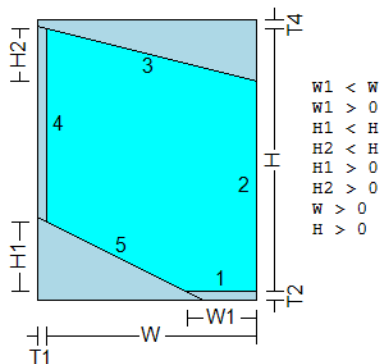

SHAPE 336

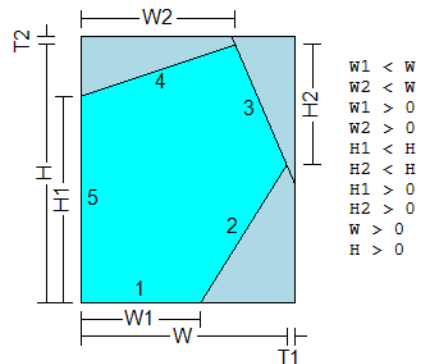

SHAPE 337

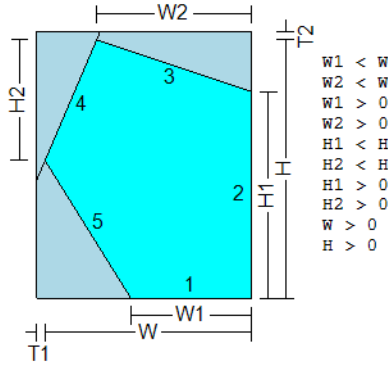

SHAPE 338

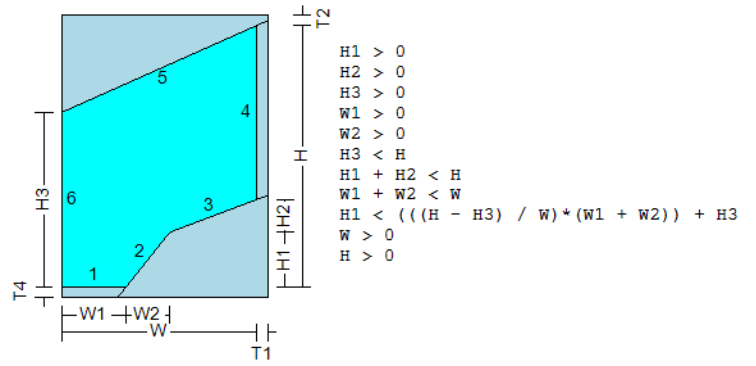

SHAPE 339

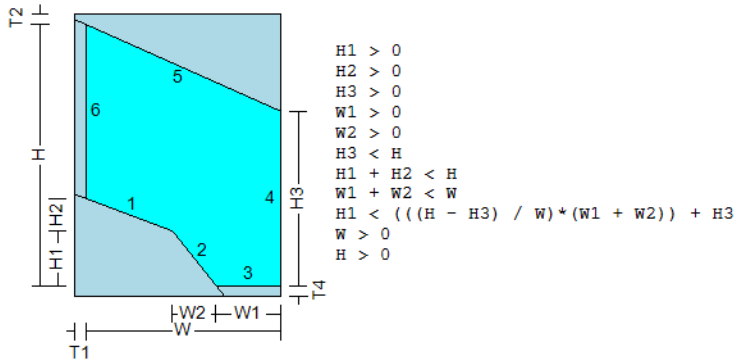

SHAPE 340

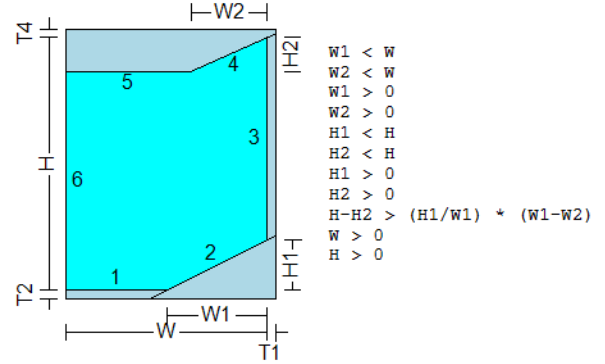

SHAPE 341

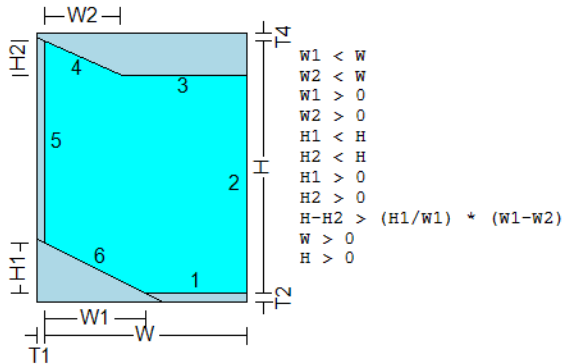

SHAPE 342

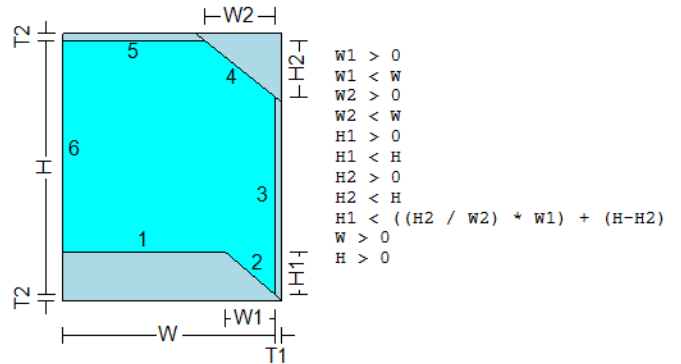

SHAPE 343

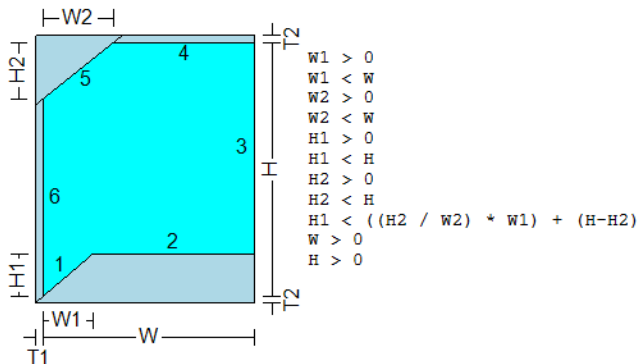

SHAPE 344

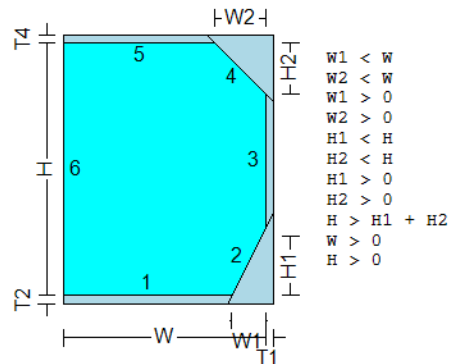

SHAPE 345

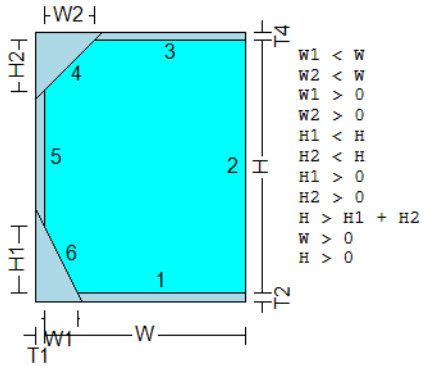

SHAPE 401

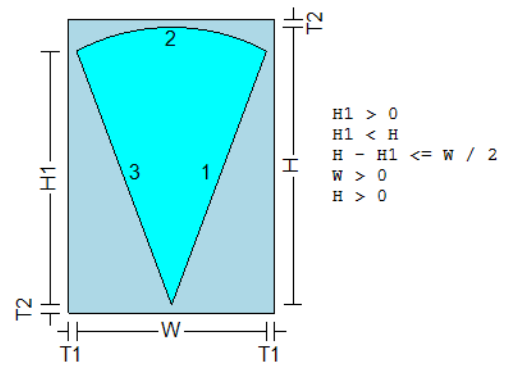

SHAPE 402

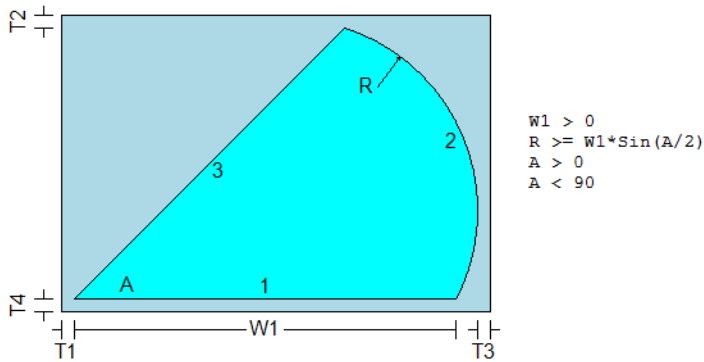

SHAPE 403

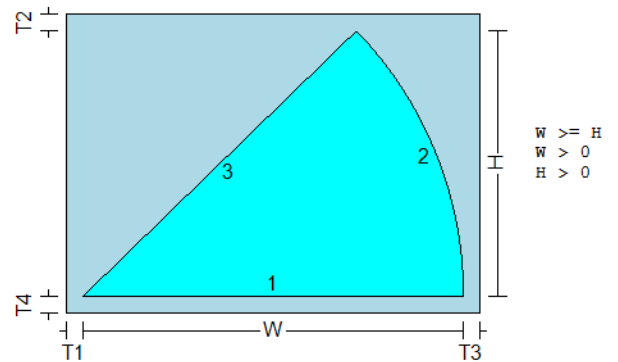

SHAPE 404

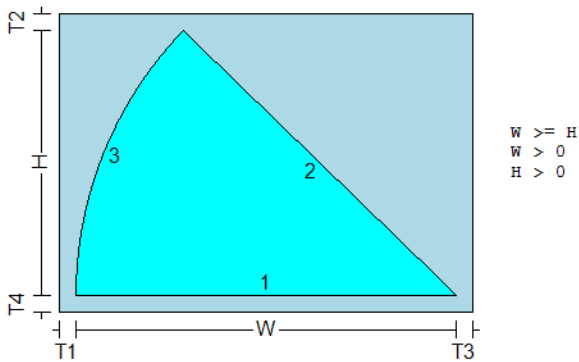

SHAPE 405

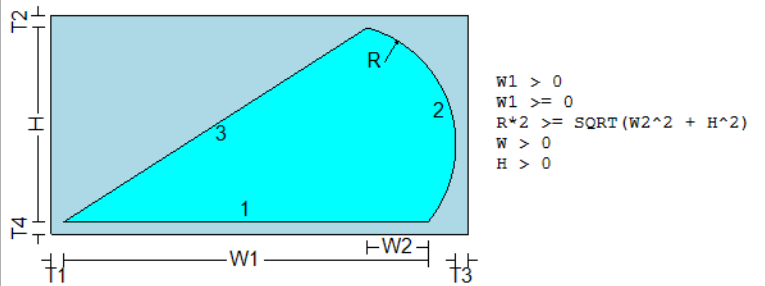

SHAPE 406

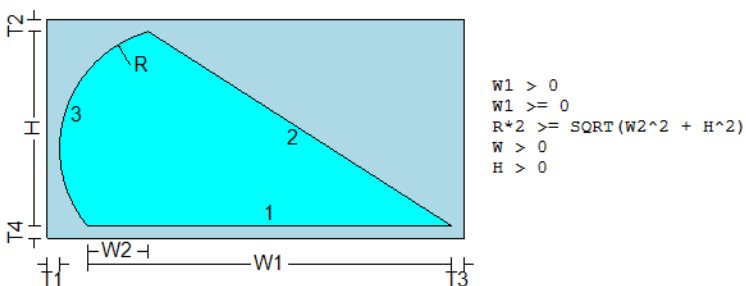

SHAPE 500

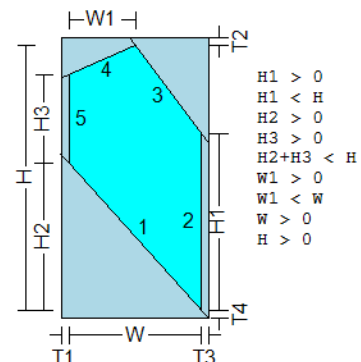

SHAPE 501

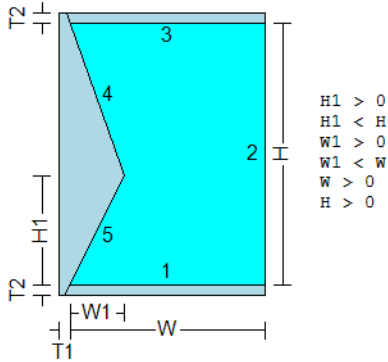

SHAPE 502

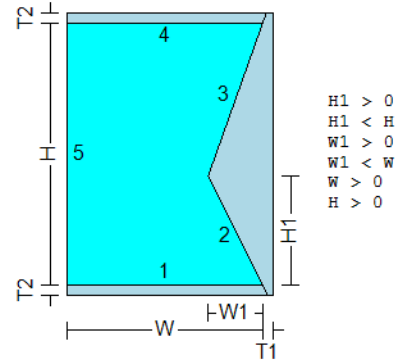

SHAPE 503

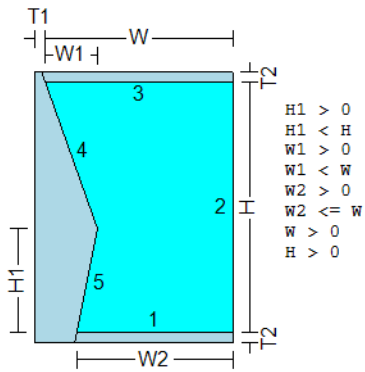

SHAPE 504

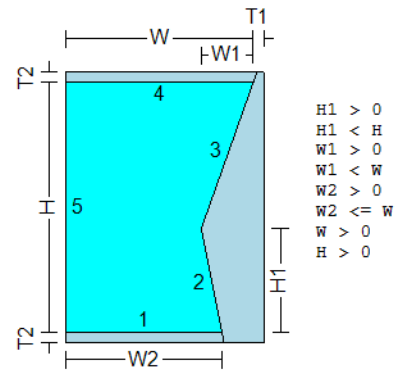

SHAPE 505

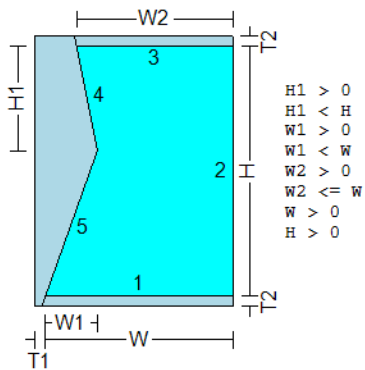

SHAPE 506

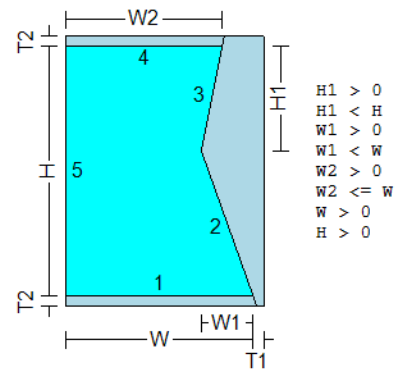

SHAPE 811

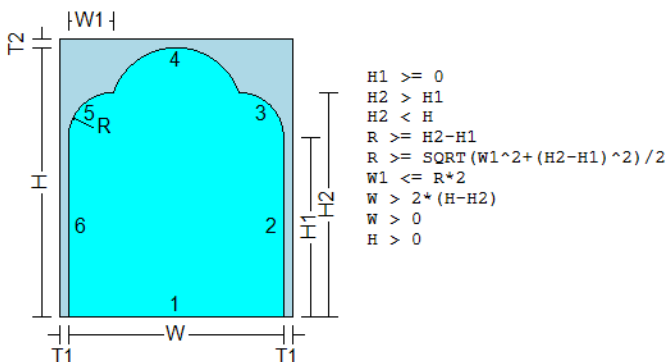

SHAPE 901

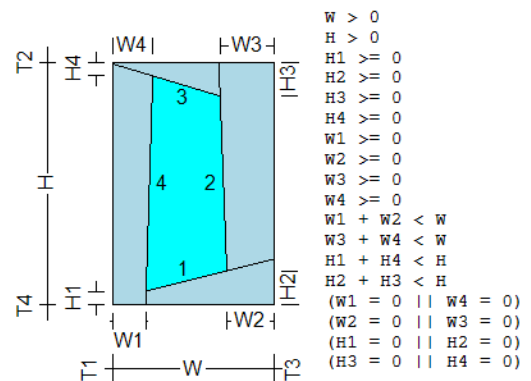

SHAPE 902

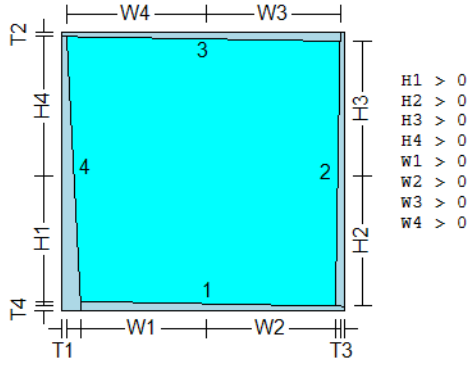

DXF - EDGEWORK SHAPE 997

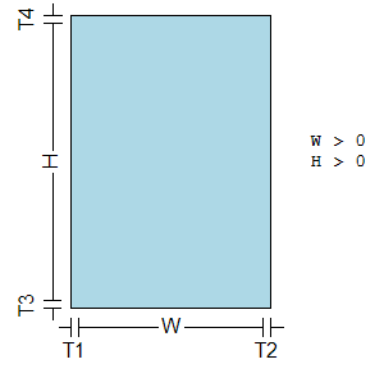

TEMPLATE SHAPE 998

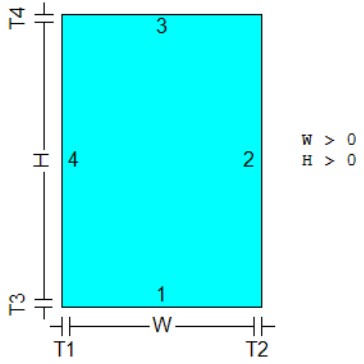

DXF SHAPE 999

